

Rozmery v mm; Maße in mm

LUGO AKKUM - SERPENTIN - 097B

227 kg

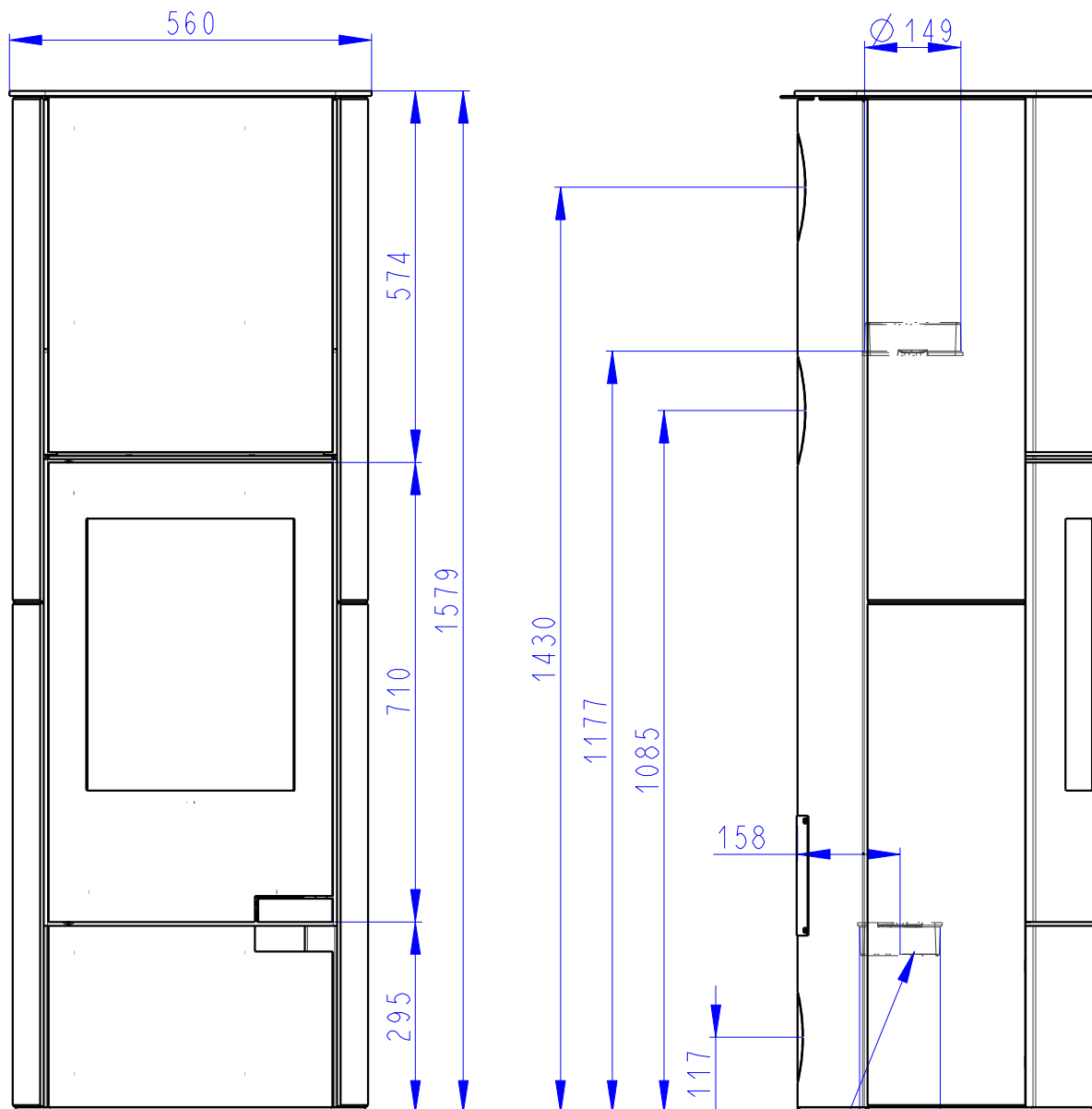

Centralni privod vzduchu
Zentralluftzufuhr
 $\varnothing 125$ mm

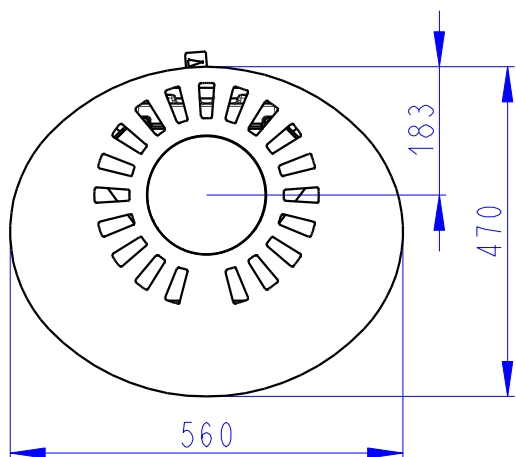

PRIMARNI VZDUCH
Primärluft
a/und
SEKUNDARNI VZDUCH
Sekundärluft

